



#### Features

- Surface Mount Devices
- Lead free device
- Size 3.2\*2.5mm/0.12\*0.10 inch
- Surface Mount packaging for automated assembly

#### Applications

- Almost anywhere there is a low voltage power supply, up to 60V and a load to be protected, including:
- Computer mother board, Modem.
  - Telecommunication equipments.

## SMD1210 Series

Alpha-Top (Sea&Land Alliance)

### Performance Specification

Model	Marking	V <sub>max</sub> (Vdc)	I <sub>max</sub> (A)	I <sub>hold</sub> @25°C (A)	I <sub>trip</sub> @25°C (A)	P <sub>d</sub> Typ. (W)	Maximum Time To Trip		Resistance		Agency Approval	
							Current (A)	Time (Sec)	R <sub>i min</sub> (Ω)	R <sub>1 max</sub> (Ω)	UL	TUV
SMD1210-005	αA	30	100	0.05	0.15	0.6	0.25	1.50	2.800	50.000		
SMD1210-005-60V	αA	60	100	0.05	0.15	0.6	0.25	1.50	2.800	50.000		
SMD1210-010	αB	30	100	0.10	0.30	0.6	0.50	0.60	0.800	15.000		
SMD1210-010-60V	αB	60	100	0.10	0.30	0.6	0.50	0.60	0.800	15.000		
SMD1210-020	αC	30	100	0.20	0.40	0.6	8.0	0.02	0.400	5.000		
SMD1210-020-60V	αC	60	100	0.20	0.40	0.6	8.0	0.02	0.400	5.000		
SMD1210-025	αC	30	100	0.25	0.50	0.6	8.0	0.02	0.400	4.500		
SMD1210-025-60V	αC	60	100	0.25	0.50	0.6	8.0	0.02	0.400	4.500		
SMD1210-035	αD	6	100	0.35	0.75	0.6	8.0	0.20	0.200	1.300	✓	
SMD1210-035-13.2V	αD	13.2	100	0.35	0.75	0.6	8.0	0.20	0.200	1.300		
SMD1210-035-16V	αD	16	100	0.35	0.75	0.6	8.0	0.20	0.200	1.300		
SMD1210-035-24V	αD	24	100	0.35	0.75	0.6	8.0	0.20	0.200	1.300		
SMD1210-050-6V	αF	6	100	0.50	1.00	0.6	8.0	0.10	0.180	0.900	✓	
SMD1210-050	αF	13.2	100	0.50	1.00	0.6	8.0	0.10	0.180	0.900		
SMD1210-050-16V	αF	16	100	0.50	1.00	0.6	8.0	0.10	0.180	0.900		
SMD1210-050-24V	αF	24	100	0.50	1.00	0.6	8.0	0.10	0.180	0.900		
SMD1210-075	αG	6	100	0.75	1.50	0.6	8.0	0.10	0.070	0.400	✓	
SMD1210-075-13.2V	αG	13.2	100	0.75	1.50	0.6	8.0	0.10	0.070	0.400		
SMD1210-075-16V	αG	16	100	0.75	1.50	0.6	8.0	0.10	0.070	0.400		
SMD1210-075-24V	αG	24	100	0.75	1.50	0.6	8.0	0.10	0.070	0.400		
SMD1210-100	αH	6	100	1.00	2.00	0.6	8.0	0.30	0.050	0.230		
SMD1210-100-13.2V	αH	13.2	100	1.00	2.00	0.6	8.0	0.30	0.050	0.230		
SMD1210-100-16V	αH	16	100	1.00	2.00	0.6	8.0	0.30	0.050	0.230		
SMD1210-110	αH	6	100	1.10	2.20	0.6	8.0	0.30	0.050	0.210	✓	
SMD1210-110-13.2V	αH	13.2	100	1.10	2.20	0.6	8.0	0.30	0.050	0.210		
SMD1210-110-16V	αH	16	100	1.10	2.20	0.6	8.0	0.30	0.050	0.210		
SMD1210-150	αL	6	100	1.50	3.00	0.6	8.0	0.50	0.030	0.110	✓	
SMD1210-150-13.2V	αL	13.2	100	1.50	3.00	0.6	8.0	0.50	0.030	0.110		
SMD1210-175	αN	6	100	1.75	3.50	0.8	8.0	0.60	0.020	0.080		
SMD1210-175-13.2V	αN	13.2	100	1.75	3.50	0.8	8.0	0.60	0.020	0.080		
SMD1210-200	αS	6	100	2.00	4.00	0.8	8.0	1.00	0.015	0.070		

**Ihold** = Hold Current. Maximum current device will not trip in 25°C still air.

**Itrip** = Trip Current. Minimum current at which the device will always trip in 25°C still air.

**Vmax** = Maximum operating voltage device can withstand without damage at rated current (I<sub>max</sub>).

**I<sub>max</sub>** = Maximum fault current device can withstand without damage at rated voltage (V<sub>max</sub>).

**P<sub>d</sub>** = Power dissipation when device is in the tripped state in 25°C still air environment at rated voltage.

**R<sub>imin/max</sub>** = Minimum/Maximum device resistance prior to tripping at 25°C.

**R<sub>1max</sub>** = Maximum device resistance is measured one hour post reflow.

**CAUTION** : Operation beyond the specified ratings may result in damage and possible arcing and flame.

### Environmental Specifications

Test	Conditions
Passive aging	+85°C, 1000 hrs.
Humidity aging	+85°C, 85% R.H. , 168 hours
Thermal shock	+85°C to -40°C, 20 times
Resistance to solvent	MIL-STD-202,Method 215
Vibration	MIL-STD-202,Method 201
Ambient operating conditions	: - 40 °C to +85 °C
Maximum surface temperature of the device in the tripped state	is 125 °C

Agency Approvals :



E201504(Alpha-Top)/E319079(Sea&Land)

Regulation/Standard:



2011/65/EU



EN14582



# SMD1210 Series

Alpha-Top (Sea&Land Alliance)

## I<sub>hold</sub> Versus Temperature

Model	Maximum ambient operating temperature (T <sub>max</sub> ) vs. hold current (I <sub>hold</sub> )								
	-40°C	-20°C	0°C	25°C	40°C	50°C	60°C	70°C	85°C
SMD1210-005	0.08	0.07	0.06	0.05	0.04	0.04	0.03	0.03	0.02
SMD1210-010	0.16	0.14	0.12	0.10	0.08	0.07	0.06	0.05	0.03
SMD1210-020	0.29	0.26	0.22	0.20	0.16	0.14	0.13	0.11	0.08
SMD1210-025	0.34	0.31	0.28	0.25	0.21	0.19	0.17	0.15	0.12
SMD1210-035	0.47	0.45	0.40	0.35	0.33	0.28	0.24	0.21	0.18
SMD1210-050	0.76	0.67	0.58	0.50	0.43	0.40	0.36	0.32	0.28
SMD1210-075	1.00	0.97	0.86	0.75	0.64	0.59	0.54	0.48	0.40
SMD1210-100	1.54	1.35	1.18	1.00	0.76	0.67	0.53	0.45	0.31
SMD1210-110	1.69	1.48	1.29	1.10	0.88	0.76	0.65	0.57	0.43
SMD1210-150	2.13	1.92	1.71	1.50	1.26	1.14	1.01	0.89	0.71
SMD1210-175	2.54	2.30	2.02	1.75	1.47	1.33	1.18	1.05	0.86
SMD1210-200	2.90	2.63	2.31	2.00	1.68	1.52	1.35	1.20	0.98

## Construction And Dimension (Unit:mm)

Model	A		B		C		D	E
	Min.	Max.	Min.	Max.	Min.	Max.	Min.	Min.
SMD1210-005	3.00	3.43	2.35	2.80	0.40	0.90	0.30	0.10
SMD1210-005-60V	3.00	3.43	2.35	2.80	0.40	0.90	0.30	0.10
SMD1210-010	3.00	3.43	2.35	2.80	0.40	0.90	0.30	0.10
SMD1210-010-60V	3.00	3.43	2.35	2.80	0.40	0.90	0.30	0.10
SMD1210-020	3.00	3.43	2.35	2.80	0.40	0.90	0.30	0.10
SMD1210-020-60V	3.00	3.43	2.35	2.80	0.40	0.90	0.30	0.10
SMD1210-025	3.00	3.43	2.35	2.80	0.40	0.90	0.30	0.10
SMD1210-025-60V	3.00	3.43	2.35	2.80	0.50	1.20	0.30	0.10
SMD1210-035	3.00	3.43	2.35	2.80	0.40	0.90	0.30	0.10
SMD1210-035-13.2V	3.00	3.43	2.35	2.80	0.40	0.90	0.30	0.10
SMD1210-035-16V	3.00	3.43	2.35	2.80	0.40	0.90	0.30	0.10
SMD1210-035-24V	3.00	3.43	2.35	2.80	0.50	1.20	0.30	0.10
SMD1210-050	3.00	3.43	2.35	2.80	0.40	0.90	0.30	0.10
SMD1210-050-16V	3.00	3.43	2.35	2.80	0.50	1.20	0.30	0.10
SMD1210-050-24V	3.00	3.43	2.35	2.80	0.50	1.20	0.30	0.10
SMD1210-075	3.00	3.43	2.35	2.80	0.40	0.90	0.30	0.10
SMD1210-075-13.2V	3.00	3.43	2.35	2.80	0.50	1.20	0.30	0.10
SMD1210-075-16V	3.00	3.43	2.35	2.80	0.50	1.20	0.30	0.10
SMD1210-075-24V	3.00	3.43	2.35	2.80	0.50	1.20	0.30	0.10
SMD1210-100	3.00	3.43	2.35	2.80	0.40	0.90	0.30	0.10
SMD1210-100-13.2V	3.00	3.43	2.35	2.80	0.50	1.20	0.30	0.10
SMD1210-100-16V	3.00	3.43	2.35	2.80	0.50	1.20	0.30	0.10
SMD1210-110	3.00	3.43	2.35	2.80	0.40	0.90	0.30	0.10
SMD1210-110-13.2V	3.00	3.43	2.35	2.80	0.50	1.20	0.30	0.10
SMD1210-110-16V	3.00	3.43	2.35	2.80	0.50	1.20	0.30	0.10
SMD1210-150	3.00	3.43	2.35	2.80	0.50	1.20	0.30	0.10
SMD1210-150-13.2V	3.00	3.43	2.35	2.80	0.50	1.20	0.30	0.10
SMD1210-175	3.00	3.43	2.35	2.80	0.50	1.20	0.30	0.10
SMD1210-175-13.2V	3.00	3.43	2.35	2.80	0.50	1.20	0.30	0.10
SMD1210-200	3.00	3.43	2.35	2.80	0.50	1.20	0.30	0.10

## Dimensions & Marking

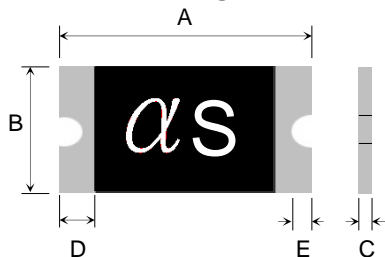

α = Trademark  
S = Part identification

## Recommended Pad Layout (mm)

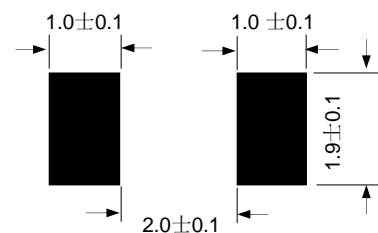

## Termination Pad Characteristics

Terminal pad materials : Gold-Plated Nickel-Copper or Tin-plated Nickel-Copper

Terminal pad solderability : Meets EIA specification RS186-9E and ANSI/J-STD-002 Category 3.

## Rework

Use standard industry practices, the removal device must be replaced with a fresh one.

## Thermal Derating Curve

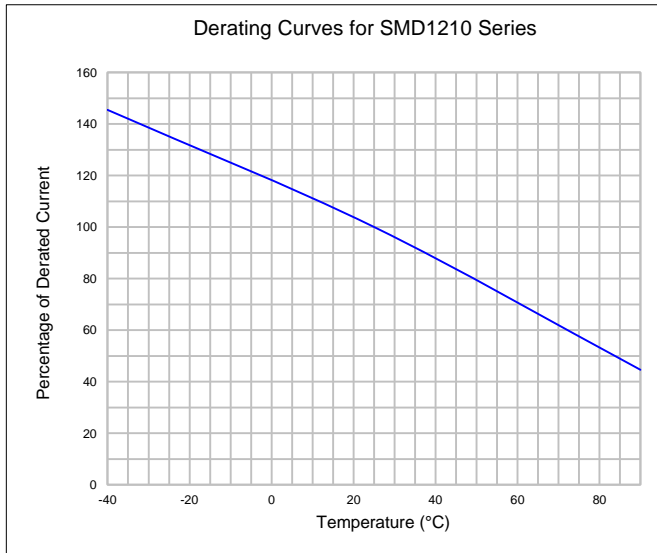

## Typical Time-To-Trip At 25°C

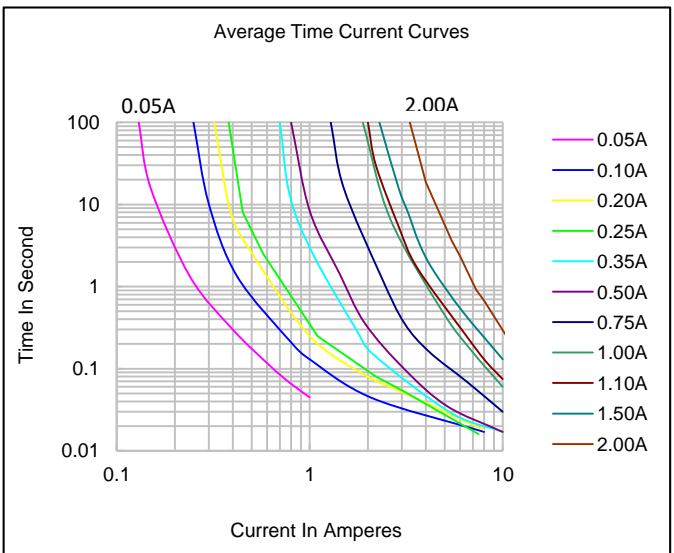

## WARNING:

- Use PPTC beyond the maximum ratings or improper use may result in device damage and possible electrical arcing and flame.
- PPTC are intended for protection against occasional over current or over temperature fault conditions and should not be used when repeated fault conditions or prolonged trip events are anticipated.
- Device performance can be impacted negatively if devices are handled in a manner inconsistent with recommended electronic, thermal, and mechanical procedures for electronic components.
- Use PPTC with a large inductance in circuit will generate a circuit voltage ( $L di/dt$ ) above the rated voltage of the PPTC.
- Avoid impact PPTC device its thermal expansion like placed under pressure or installed in limited space.
- Contamination of the PPTC material with certain silicon based oils or some aggressive solvents can adversely impact the performance of the devices. PPTC SMD can be cleaned by standard methods.
- Requests that customers comply with our recommended solder pad layouts and recommended reflow profile. Improper board layouts or reflow profile could negatively impact solderability performance of our devices.

**Recommended Solder Reflow Conditions**

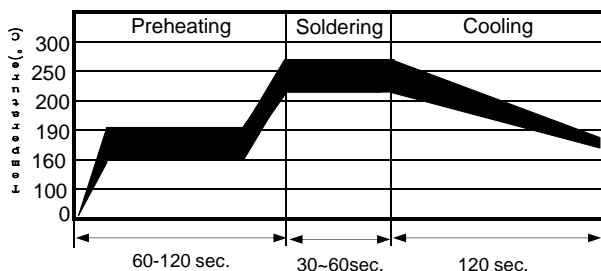

- Recommended reflow methods : IR, vapor phase oven, hot air oven.
  - Devices are not designed to be wave soldered to the bottom side of the board.
  - Recommended maximum paste thickness is 0.25 mm (0.010 inch).
  - Devices can be cleaned using standard method and solvents.
- Note : If reflow temperatures exceed the recommended profile, devices may not meet the performance requirements.

**Tape And Reel Specifications (mm)**

Governing Specifications	EIA 481-2
W	8.0 ± 0.20
P0	4.0 ± 0.10
P1	4.0 ± 0.10
P2	2.0 ± 0.10
A0	2.82 ± 0.10
B0	3.52 ± 0.10
B1max.	4.35
D0	1.5 + 0.1, -0.0
F	7.5 ± 0.05
E1	1.75 ± 0.10
E2min.	6.25
Tmax.	0.6
T1max.	0.1
K0	0.90 ± 0.1
Leader min.	390
Trailer min.	160
<b>Reel Dimensions</b>	
A max.	178
N min.	50
W1	8.4 + 1.5, -0.0
W2max.	22.4

**EIA Tape Component Dimensions**

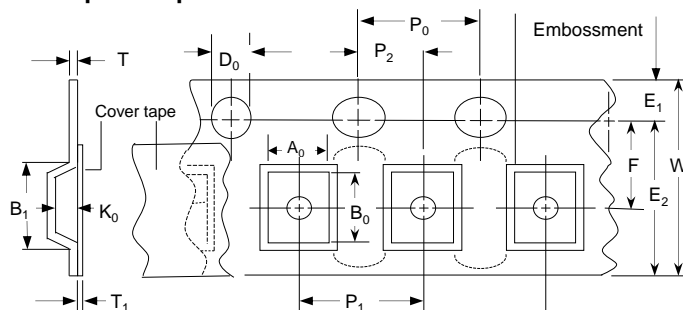

**EIA Reel**

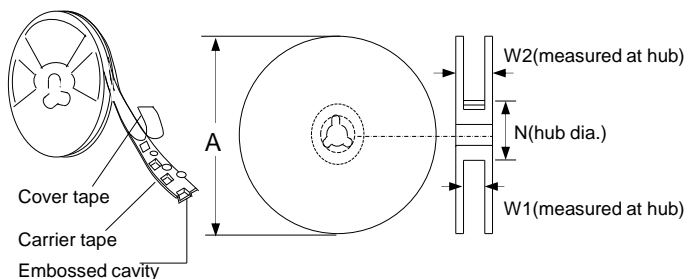

**Storage And Handling**

- Storage conditions : 40°C max, 70% R.H.
- Devices may not meet specified performance if storage conditions are exceeded.

**Order Information**

**Packaging**

SMD1210	050	Tape & Reel Quantity	
Product name	Hold Current	SMD1210 Series	4,500 pcs/reel
Size 3225 mm / 1210 inch	0.50A		
SMD : surface mount device			

Devices taped with reference to EIA481 standard.